



港照照明科技有限公司  
**Kong Lighting Technology Ltd**  
 HK Office: Flat 24, 8/F., Block A, Hoi Luen Ind.  
 Centre, 55 Hoi Yuen Rd, Kwun Tong, Kowloon,  
 Hong Kong  
 Tel: (852) 21857600, Fax: (852) 2185 7608

China Factory: Lijiafang Industry Zone, Shipai,  
 Zhen, Dongguan, Guangdong, China  
 Tel: (769) 81273588, Fax: (769) 81082986  
 E-mail: [info@konglighting.com](mailto:info@konglighting.com),  
[sales@konglighting.com](mailto:sales@konglighting.com)  
[www.Konglighting.com](http://www.Konglighting.com)

# 5050 4 CCT( WT + NW + RR or RY Color) Flexible Led strip Light

**5050 SRRW & SRYW**  
**(6000-6500K) White / (2800-3200K) Warm White**



(Red)  
620~625nm



(Warm White)  
2800-3200K



(White)  
6000-6500K



(Yellow)  
588~592nm

## Formal Specification





港照照明科技有限公司

Kong Lighting Technology Ltd

HK Office: Flat 24, 8/F., Block A, Hoi Luen Ind.  
Centre, 55 Hoi Yuen Rd, Kwun Tong, Kowloon,  
Hong Kong  
Tel: (852) 21857600, Fax: (852) 2185 7608

China Factory: Lijiafang Industry Zone, Shipai,  
Zhen, Dongguan, Guangdong, China  
Tel: (769) 81273588, Fax: (769) 81082986  
E-mail:[info@konglighting.com](mailto:info@konglighting.com),  
[sales@konglighting.com](mailto:sales@konglighting.com)

[www.Konglighting.com](http://www.Konglighting.com)

---

## High brightness 5050 Flexible Strip Light.

It's a high brightness output strip to satisfied customer who is seeking a high brightness of the lighting and brilliant colors, consistency effects. Compare with traditional decorative light, such as neon light, rope light etc., they are more flexible, energy saving, easy to install, safe and environmentally friendly, widely use in all applications.

In addition, with its 4 channel control system, different colour mixture and effect can be achieved, they are also evenly placed in the FPC board, color are more brightness and consistent.

## Innovative Design, ideal for meat, bread, vegetable or supermarket lighting

Warm white + White + optional : two red or red plus yellow color make your product more attractive and eye catching. ( Traditional meat strip with 1 red light only).

## Flexible in length suitable for different applications

LED Strip light use high tech. double-faced FPC soft , FPC width :12 mm

PCB to ensure the good electrical conductivity and power voltage drop, special designed with thicker copper circuit, however for many other suppliers, they use single faced soft PCB.

## Non-waterproof and waterproof available

Non-waterproof and waterproof version for different applications.

## Different colors for choice for different applications:

### 2 Year warranty

KL LED strips are use good materials and super light sources with low lumens depreciation, which make the strips with long life-span 30,000 hours, and we offer 2 years warranty.

## Environmental friendly

KL LED strips are complied with CE and ROHS standard without harmful substance, such as lead or Mercury, etc.



港照照明科技有限公司

Kong Lighting Technology Ltd

HK Office: Flat 24, 8/F., Block A, Hoi Luen Ind.  
Centre, 55 Hoi Yuen Rd, Kwun Tong, Kowloon,  
Hong Kong  
Tel: (852) 21857600, Fax: (852) 2185 7608

China Factory: Lijiafang Industry Zone, Shipai,  
Zhen, Dongguan, Guangdong, China  
Tel: (769) 81273588, Fax: (769) 81082986  
E-mail:[info@konglighting.com](mailto:info@konglighting.com),  
[sales@konglighting.com](mailto:sales@konglighting.com)

[www.Konglighting.com](http://www.Konglighting.com)

Feature	
Light source	5050 SMD
Product size	5000 x 12 x 2.2 mm ( Length x width x thickness)
Viewing angle	> 120°
Colors available	WT + NW + optional RR Or RY: RR (DOUBLE RED) or Red plus Yellow available
Working Voltage	DC12V (DC24V available)
IP Grade available	IP20, IP54, IP65, IP67, Nano coating
Adhesive tape	3M self-stick tapes, easy for installation can be provided if require
Solder connection point	Every 3 LED(DC12V) or 6 LED(DC24V) are cuttable
Nos. of Led/meter	30, 60, 72, 84, 96
Working temperature	-20°C ~ +45°C
Storage temperature	0°C ~ +60°C

Electrical/ Optical Characteristics at TA=25°C

Dimension: 5000 x 8mm Parameter	Symbol	Absolute Maximum Rating	Unit
		KL-FCW0-60/72/84/96B-24V	
Forward Current	IF	600 / 720 / 840 / 960	mA
Forward Voltage	V	24	V
Viewing Angle	$2\theta$ 1/2	120	deg
Electrostatic Discharge	ESD	4000	V
Operating Temperature	Topr	-20 ~ +60	°C
Storage Temperature	Tstg	-40 ~ +80	°C



港照照明科技有限公司

Kong Lighting Technology Ltd

HK Office: Flat 24, 8/F., Block A, Hoi Luen Ind.  
Centre, 55 Hoi Yuen Rd, Kwun Tong, Kowloon,  
Hong Kong  
Tel: (852) 21857600, Fax: (852) 2185 7608

China Factory: Lijiafang Industry Zone, Shipai,

Zhen, Dongguan, Guangdong, China

Tel: (769) 81273588, Fax: (769) 81082986

E-mail: [info@konglighting.com](mailto:info@konglighting.com),

[sales@konglighting.com](mailto:sales@konglighting.com)

[www.Konglighting.com](http://www.Konglighting.com)

Electrical / optical properties TA = 25°C

Model.	Colour	Colour Temperature CCT/WLD	lumen	Work Voltage	Current	Power
KL-SRYW060B-24V	White	6000-6500K	350 lm	24VDC	0.60A	14.4W
	Red	620-630nm	40 lm			
	Yellow	588~592nm	85lm			
	Warm white	28003200K	345 lm			
	SRYW	770Lm				
KL-SRYW072B-24V	White	6000-6500K	418 lm	24VDC	0.72A	17.28W
	Red	620-630nm	47 lm			
	Yellow	588~592nm	99lm			
	Warm white	28003200K	407lm			
	SRYW	885Lm				
KL-SRYW084B-24V	White	6000-6500K	493 lm	24VDC	0.84A	20.16W
	Red	620-630nm	57 lm			
	Yellow	588~592nm	120lm			
	Warm white	28003200K	490 lm			
	SRYW	1081Lm				
KL-SRYW096B-24V	White	6000-6500K	543 lm	24VDC	0.96A	23.04W
	Red	620-630nm	62 lm			
	Yellow	588~592nm	131lm			
	Warm white	28003200K	531 lm			
	SRYW	1178Lm				

- Note: 1. The luminous flux of tolerance is  $\pm 10\%$ ,  
 2. The test temperature (ambient temperature, TA = 25 °C) ,  
 3.all the technical parameters are based on the maximum per meter.



港照照明科技有限公司  
Kong Lighting Technology Ltd  
HK Office: Flat 24, 8/F., Block A, Hoi Luen Ind.  
Centre, 55 Hoi Yuen Rd, Kwun Tong, Kowloon,  
Hong Kong  
Tel: (852) 21857600, Fax: (852) 2185 7608

China Factory: Lijiafang Industry Zone, Shipai,  
Zhen, Dongguan, Guangdong, China  
Tel: (769) 81273588, Fax: (769) 81082986  
E-mail: [info@konglighting.com](mailto:info@konglighting.com),  
[sales@konglighting.com](mailto:sales@konglighting.com)

[www.Konglighting.com](http://www.Konglighting.com)

※ Dimension

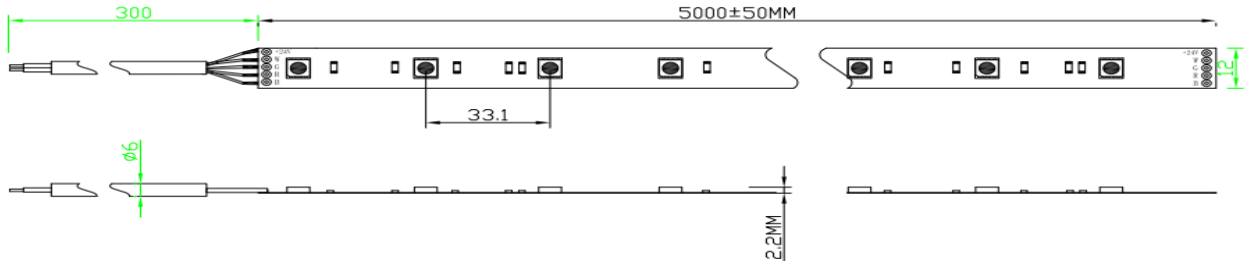

▲ KL-XXXX030B-12

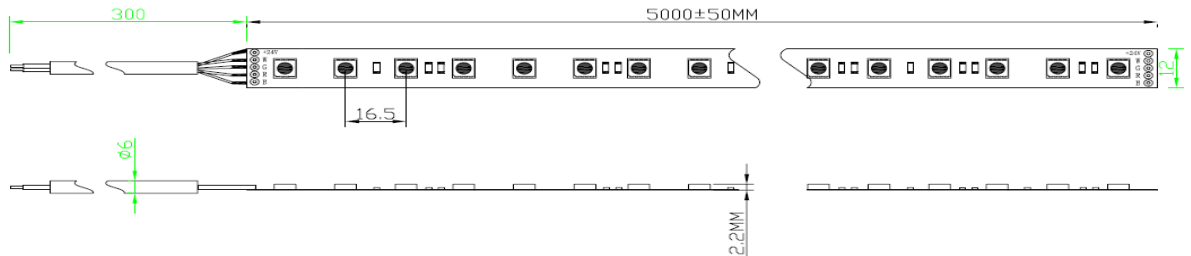

▲ KL-XXXX060B-24

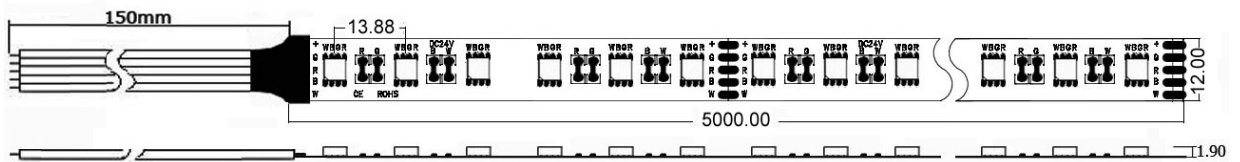

▲ KL-XXXX072B-24

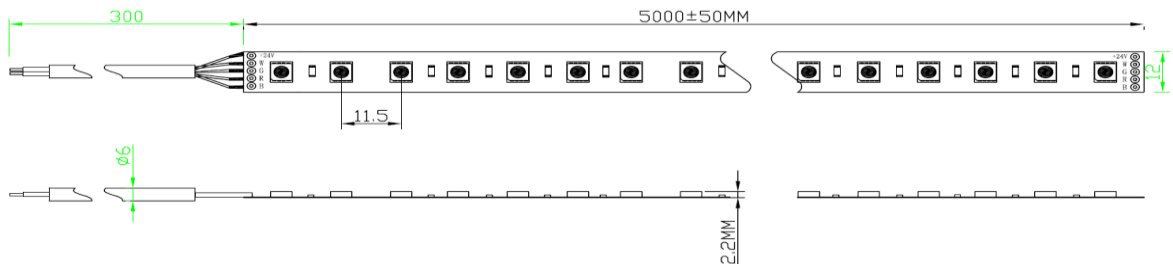

▲ KL-XXXX084B-24

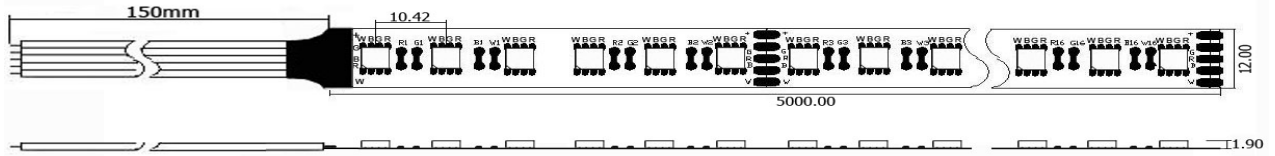

▲ **KL-XXXX096B-24**

All dimension are in centimeter

Unless otherwise stipulated, the deviation as below:

≥5mm, Tolerance ±0.5mm (0.02 ")

<5mm, Tolerance ±0.05mm (0.002 ")

※ Connection Diagram (12V, 24V same )

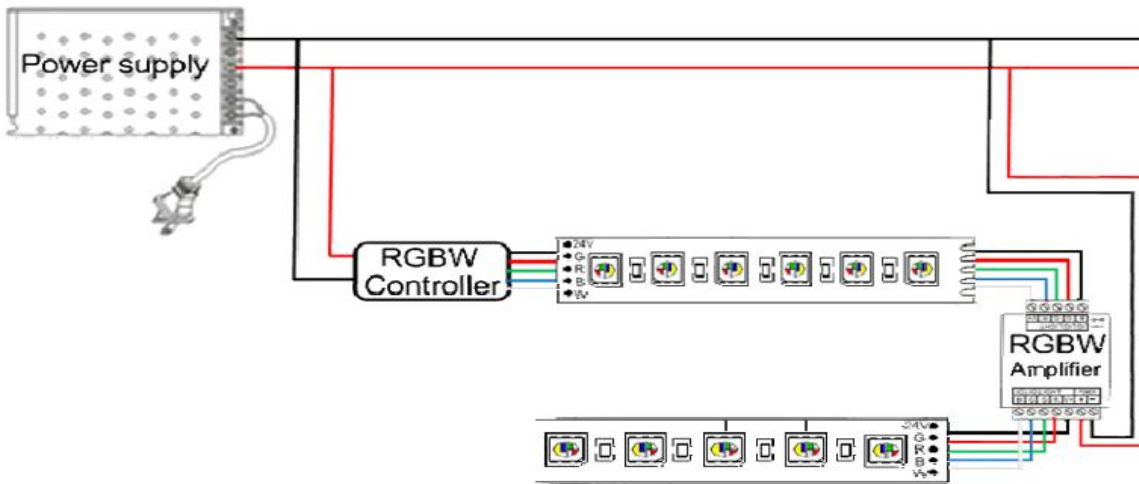

**Note:**

1. Above diagram for reference only, please follow the instruction to install.
2. Please make sure the strip light connection well before the power on.
3. in parallel connection.

※ Application

Suitable for various applications and special lighting effects.

Flexible strips is mainly used in food, meat/bread or the super market.





港照照明科技有限公司

Kong Lighting Technology Ltd

HK Office: Flat 24, 8/F., Block A, Hoi Luen Ind.  
Centre, 55 Hoi Yuen Rd, Kwun Tong, Kowloon,  
Hong Kong  
Tel: (852) 21857600, Fax: (852) 2185 7608

China Factory: Lijiafang Industry Zone, Shipai,  
Zhen, Dongguan, Guangdong, China  
Tel: (769) 81273588, Fax: (769) 81082986  
E-mail: [info@konglighting.com](mailto:info@konglighting.com),  
[sales@konglighting.com](mailto:sales@konglighting.com)

[www.Konglighting.com](http://www.Konglighting.com)

They can also be used as edge light, cove light, furniture light, sign light, backlighting for adWords, lighting box etc., and widely used as decorative lighting for building outline, sidestep, exhibition stand, hotel, KTV, club etc and also DIY Light for household use.



#### ※ Safety information

- The SMD light ribbon itself and all its components may not be mechanically stressed. Assembly must not damage or destroy conducting paths on the circuit board.
- To ensure a better brightness performance, wire of each strip light (in every 5 meter) should be connected with main power supply .
- Installation of LED light ribbon (with power supplies) needs to be comply with all applicable electrical and safety standards. Only qualified personnel should be allowed to perform installations. Correct electrical polarity needs to be observed. Wrong polarity may destroy the ribbon. In addition, to ensure each wire (GND) have connected together.
- To ensure the life and reliability of the lights, do not bend product in curve which is below 60mm diameter, folding, longitudinal bend to avoid breakage of strip.
- When the power is turn on, touch the AC power supply terminal could endanger your safety.
- For practical use, 20% electricity to be reserved to ensure there is enough electricity to light up the LED.
- Parallel connection is highly recommended as safe electrical operation model.
- Serial connection is not recommended. Unbalanced voltage drop can cause hazardous overload than damage the ribbon.
- Please ensure the power supply is of adequate power to operate the total load.
- When mounting on metallic or otherwise conductive surfaces, there needs to be an electrical insulated points between ribbon and the mounting surface.
- Please pay attention to standard ESD precautions when installing the ribbon.



港照照明科技有限公司  
Kong Lighting Technology Ltd  
HK Office: Flat 24, 8/F., Block A, Hoi Luen Ind.  
Centre, 55 Hoi Yuen Rd, Kwun Tong, Kowloon,  
Hong Kong  
Tel: (852) 21857600, Fax: (852) 2185 7608

China Factory: Lijiafang Industry Zone, Shipai,  
Zhen, Dongguan, Guangdong, China  
Tel: (769) 81273588, Fax: (769) 81082986  
E-mail: [info@konglighting.com](mailto:info@konglighting.com),  
[sales@konglighting.com](mailto:sales@konglighting.com)

[www.Konglighting.com](http://www.Konglighting.com)

- Damaged by corrosion will not be honored as a materials defect claim. It is the user's responsibility to provide suitable protection against corrosive agents such as moisture and condensation and other harmful elements.



※ Package

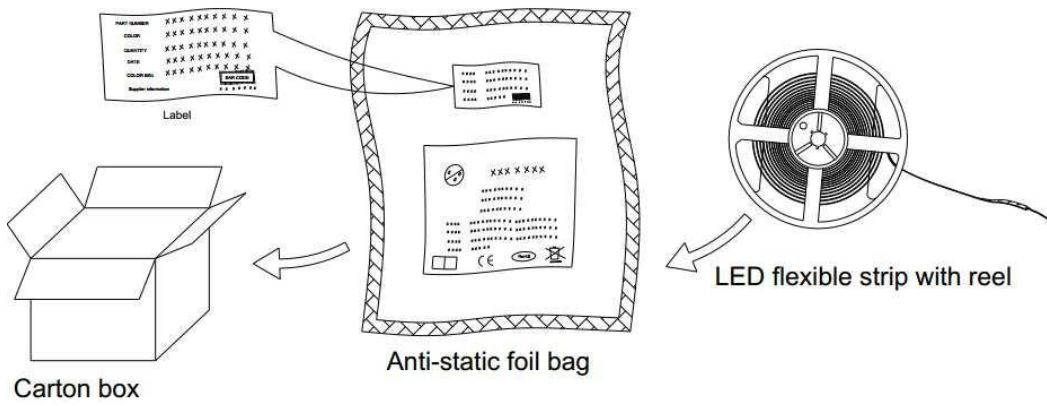

All details, terms and conditions are subject to change without prior notice.